

SAEPTUM SYSTEM



SAEPTUM

Sistema per il contenimento dell'acqua, il fissaggio e la finitura della zona a pavimento dei box doccia scorrevoli serie RS, RSZ e MS

Vetro fisso inserito in profilo diga continuo IPD01 + profilo cover a scatto IPC03

Estruso in lega di alluminio

Water containment, fixing and floor area finishing system for RS, RSZ and MS shower rooms series

Fixed glass panel inserted into IPD01 floor dam profile + IPC03 clicking closing profile

Extruded aluminium alloy

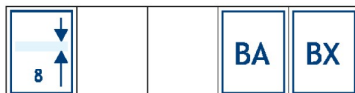

IPG01L

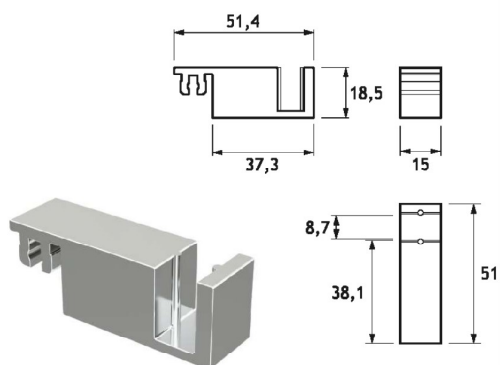

Guida a pavimento per sistemi diga SAEPTUM e REDUCTA
Fissaggio a pressione con IPD01 e IPD03
Realizzata in poliammide metallizzato

Floor guide for SAEPTUM and REDUCTA dam systems
Pressure fixing with IPD01 and IPD03
Metallized polyamide manufacturing

			BK	BA
--	--	--	----	----

IPD01

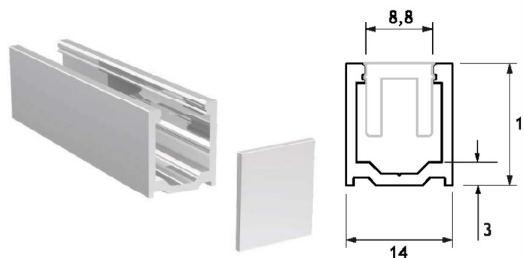

Canalina di contenimento acqua e/o per fissaggio a
pavimento del vetro laterale per sistemi IPC, RS, RSZ e MS
Estruso in lega di alluminio
Lunghezza delle barre mm 1500-2200

«U» profile floor dam and/or floor fixing of the side glass
For IPC, RS, RSZ e MS systems
Extruded aluminium alloy
Bar lenght: 1500-2200 mm

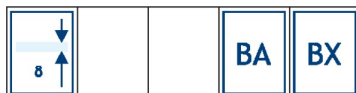

IPC03

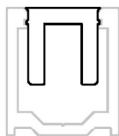

SAEPTUM profilo di chiusura a scatto per IPC01 e IPD01
Si utilizza per chiudere e rifinire la diga
Estruso in lega di alluminio
Lunghezza delle barre mm 1500-2200

SAEPTUM clicking closing profile for IPC01 and IPD01
It is used to close and finish the dam
Extruded aluminium alloy
Bar length: 1500-2200 mm

			BA	BX
--	--	--	----	----

SAEL-145/SAEL-220



Kit profili SAEPTUM per cabine doccia a un'anta disponibile in due misure e costituito da:

1 pz IPD01, 1 pz IPC03, 1 pz IPG01L, 2 pz piastrelle di finitura testa profilo

Estruso in lega di alluminio

Lunghezza della barra mm 1500 e 2200 a seconda del kit

SAEPTUM profiles set for single door shower rooms available in two sizes and composed of:

1 pc IPD01, 1 pc IPC03, 1 pc IPG01L, 2 pcs profile finishing plates

Extruded aluminium alloy

Bar length: 1500 and 2200 mm according to the set

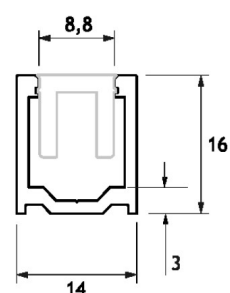

SAEL90

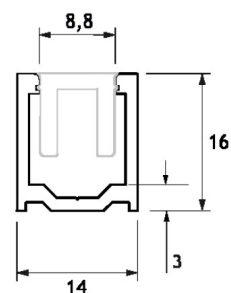

Kit profili SAEPTUM per cabine doccia a doppia anta a 90° costituito da:
2 pz IPD01, 2 pz IPC03, 2 pz IPG01L
Estruso in lega di alluminio
Lunghezza delle barre mm 2200

SAEPTUM profiles set for 90° double door shower rooms composed of:
2 pcs IPD01, 2 pcs IPC03, 2 pcs IPG01L
Extruded aluminium alloy
Bars length: 2200 mm

